



LabSmith

TOOLS FOR SCIENCE

LabSmith Microfluidic Products

For Fast Connection, Flow Control and Automation

- ▶ Ferrules and fittings for leak-free connections
- ▶ Programmable components to automate flows
- ▶ High voltage power supplies for electrophoresis and more
- ▶ Inverted fluorescence microscopes for research-grade images and video

Microfluidic research as it should be

LabSmith designs laboratory equipment that helps researchers get down to science, directly and painlessly. Our components also help companies to develop analytic systems that generate accurate data, day in and day out.

LabSmith was founded by researchers. We know what it means to lose hours trying to prototype experiments from spare parts and random components. We know the value of having a setup that *simply works*, time and again, without distraction.

Coordinated devices and software

LabSmith's reliable, affordable and inter-compatible products are designed to take the hassle out of microfluidic circuits. Leak-free connectors, pumps and valves assemble quickly for efficient fluid routing. Automated devices manage flow, pressure, temperature and high voltage, with easy-to-learn software coordinating it all, seamlessly. And, our groundbreaking video microscopes include the right features to capture elusive events and output impressive images and video.

Learn how LabSmith's Tools for Science can help you speed your research and product development cycles.

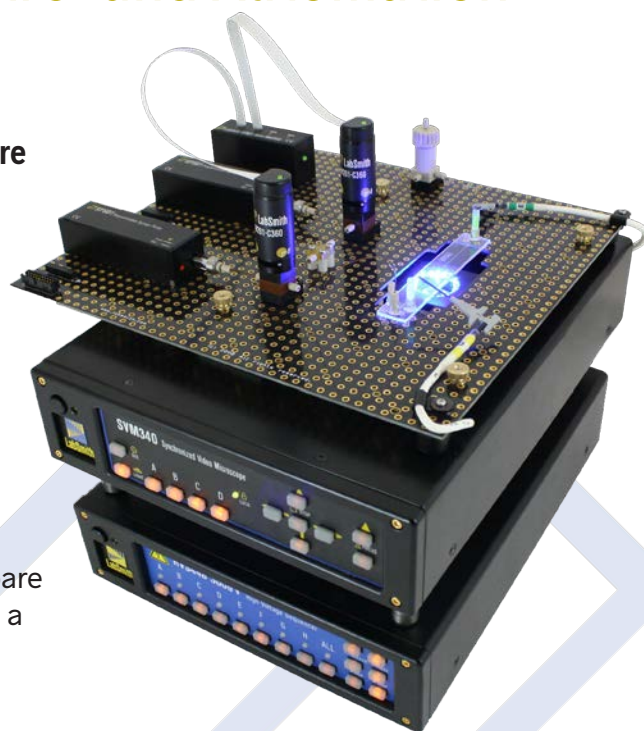

Microfluidic Circuit Construction

LabSmith microfluidic construction components make it easy and affordable to assemble microfluidic setups for research and OEM applications.

Leak-Free Fittings and Fixtures

CapTite™ reusable components provide worry-free fluid routing and long life over multiple runs—even at high pressures. Use CapTite fittings to construct fluid circuits with 360µm capillary, 1/32" & 1/16" tubing. All components are designed for low dead volumes, easy cleaning, and long life over multiple runs.

LabSmith's breadboard-mounted interconnects, reservoirs, pumps and valves make it easy to build microfluidic and nanofluidic setups. Then, take them apart and reuse the components, time and time again. It's the easy, affordable way to experiment, prototype, or design analytic devices.

- One-piece ferrules and plugs
- Unions, tees, wyes and crosses
- 3-, 4- and 6-port manual valves
- Cartridges and filter holders
- Tubing and capillary
- Microfluidic chips
- Syringes and tools
- Reservoirs
- Breadboards

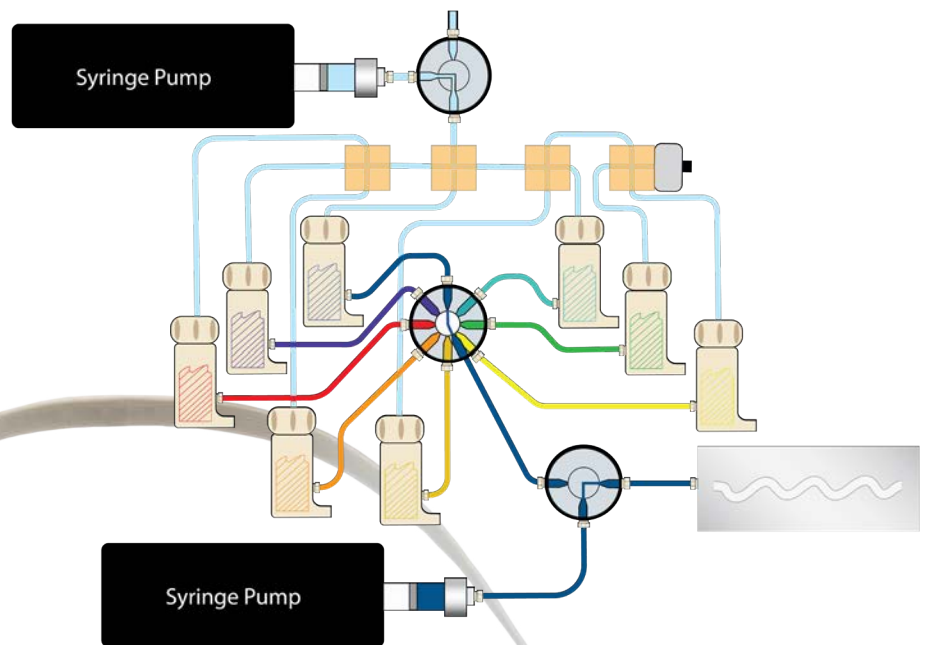
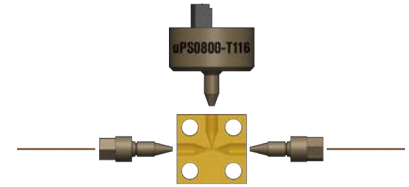
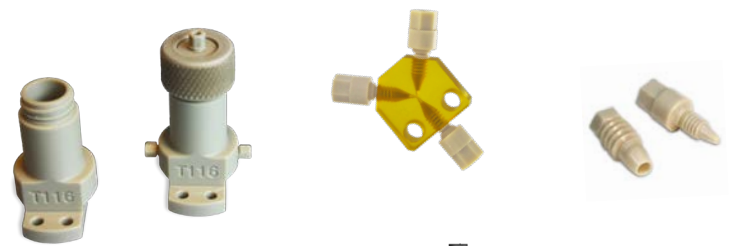

Easy Microfluidics Automation

Automated Devices and Sensors

LabSmith's uProcess™ system is a groundbreaking platform for automating microfluidic flows. Coordinate valves, pumps, sensors, voltage supplies and other components for fast, straightforward automation—at a small fraction of the cost of custom, single-use components.

Whether you are using microfluidic circuits in your research or developing analytical instruments, uProcess and CapTite products offer the most flexible, affordable option to get you to science, fast.

Automated syringe pumps

3-, 4-, 6- and 9-port valves

Pressure and temperature sensors

Temperature controllers

Electrophoresis power supplies

Manifolds for quick connection

Complete experiment kits

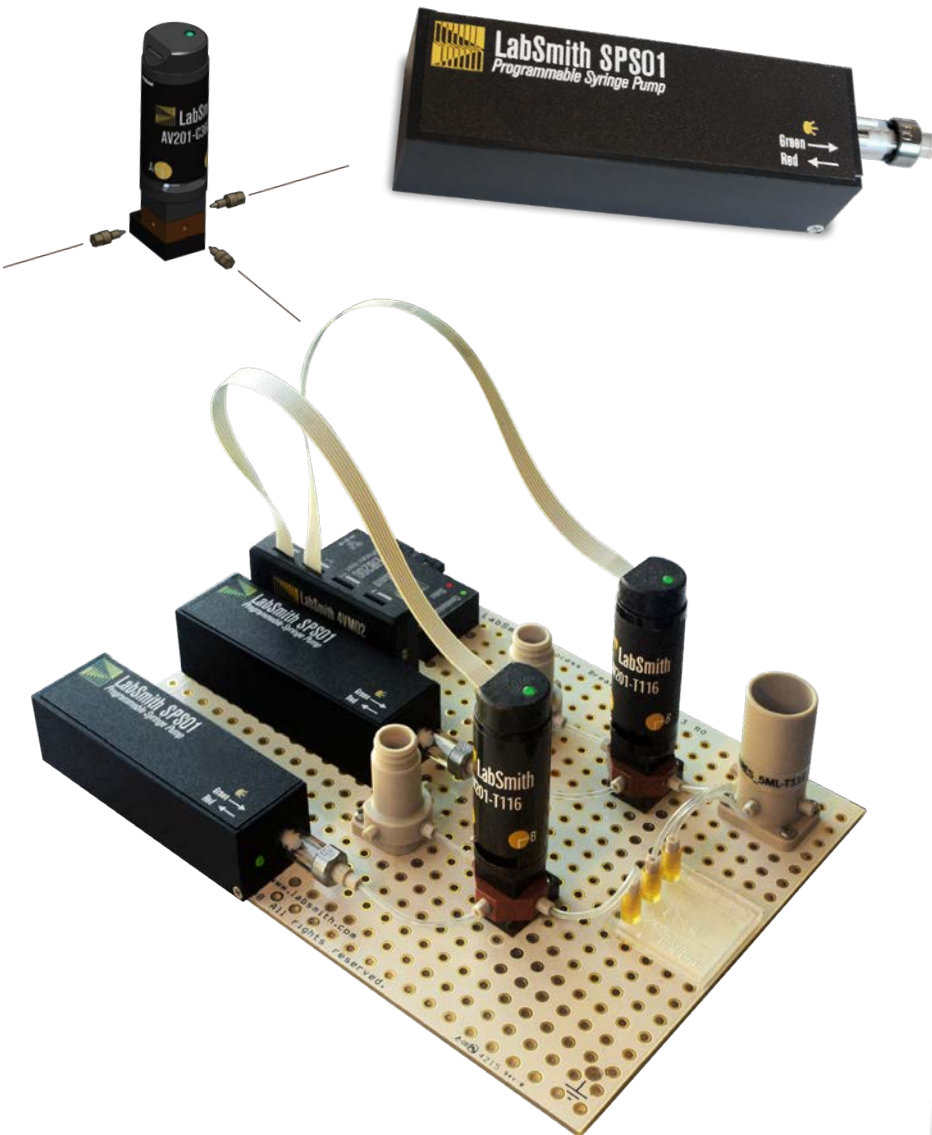

Simple, Powerful Coordination

uProcess scripting software coordinates and automates microfluidic systems. Use uProcess's simple scripting to integrate dozens of devices into simple or complex microfluidic systems—without laboring over custom code.

uProcess is the only system that coordinates all aspects of your experiment, including flow, pressure, temperature and voltage. You can even integrate uProcess with our SVM microscopes to trigger video capture of events based on live circuit parameters.

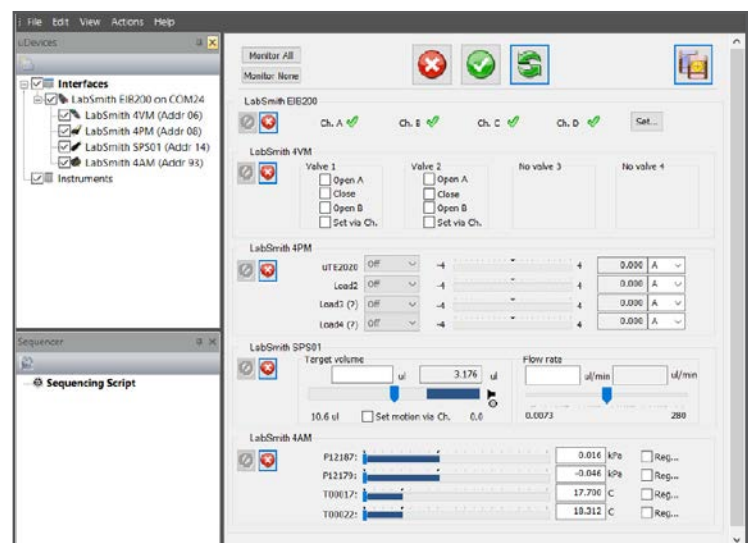

Microscopy and Voltage Control

Impressive, Affordable Microscopy for Microfluidics

The SVM is a research-grade, inverted fluorescence video microscope for microfluidics and microbiology. This unique, highly versatile microscope excels precisely where it counts: acquiring high-quality experimental data and images, quickly.

The inverted design with motorized traverse ensures that biological systems remain unperturbed. Image-based “soft triggers” make the SVM perfect for μ TAS prototypes and miniature process automation. An extensive array of filter, camera, illumination, objective and analysis options let you tailor the system for your research.

The SVM includes imaging software with an impressive feature set. Particle Counting Probes let you count and characterize particles in real-time, at up to 5000 particles per frame, based on absorption, scattering, refraction or fluorescence.

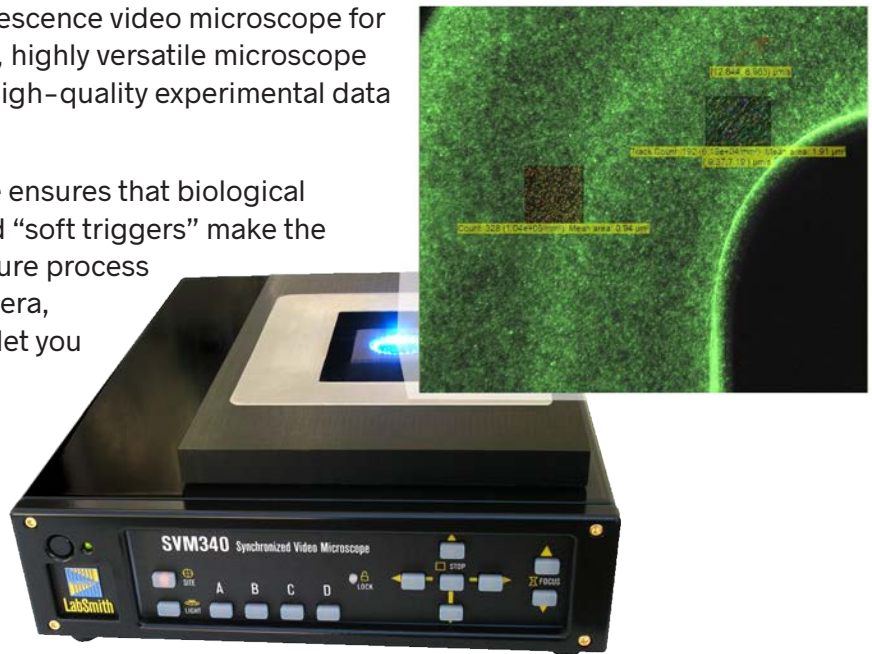

Agile High Voltage Power Supplies

LabSmith's fully-programmable high voltage power supplies support a wide range of electrically driven flow applications. Eight-channel HVS High Voltage Sequencers let you apply up to 8000V, and rapidly switch channels through different modes and settings based on real-time calculations, measurements, or programmed sequences. With innovative voltage/current supply and sensing, in a ground-breaking sequencing environment, the HVS448 integrates your entire experiment, simply and safely.

Our compact, 300V uEP modules provide precision voltage, current or power control, ideal for electrophoresis and gel electrophoresis setups. The uEP is controlled with our uProcess software. It can function as a standalone power supply, or it can be used in conjunction with uProcess sensors for constant pressure or temperature modes.

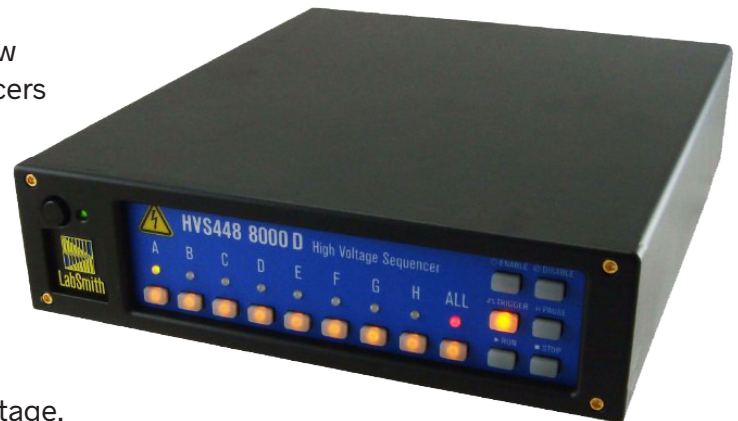

Count on LabSmith

LabSmith has been at the vanguard of microfluidics for almost 20 years. We back our unique products with accessible support, regular updates, and new features based on our customers' needs. Call today to learn more about LabSmith's Tools for Science.

LabSmith | info@labsmith.com | www.labsmith.com

5981 Graham Court | Livermore, CA 94550 | (925) 292-5161

