

CATALOG

A-GEN Biotech Catalog

A-GEN
A-GEN YOUR CLEAR CHOICE

Hangzhou A-GEN Biotech (Headquarter) :

No. 7,Tangwang Street, Linping District, Hangzhou, Zhejiang, China.

Zhejiang A-GEN Biotech :

Green Incubation Industrial Park, No. 3 Taikang Road, Kaihua County, Quzhou City, Zhejiang Province,China.

Tel : 86-0571-86358706
Email : info@a-gen.com
Website : en.a-gen.com

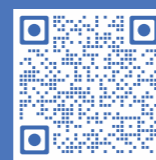

Alibaba Website



Made In China
Website

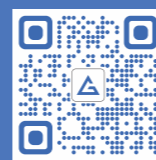

Official Website

A-GEN[®]
A-GEN.YOUR CLEAR CHOICE

Product Series

Product Contents



Automatic Pipette Tips



Universal Pipette Tips



Plate

Deep Well Plate / PCR Plate / Silicone Mat / Sealing Film



Reservoir



Tube/Column



Reagent Bottle



Serological Pipettes

Compatibility List For Agilent And Amtk Tips



Package: 384 pcs/rack , 96 pcs/rack
 Volume: 30uL , 70uL , 250uL
 Material: Medical grade polypropylene
 Temperature range: -80°C-121°C

Compatibility List For Beckman And Nayo Tips

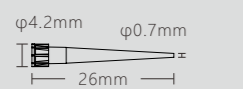
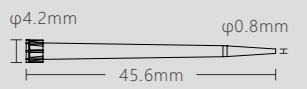
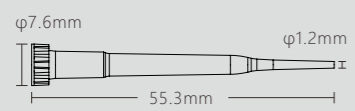

Package: 96 pcs/rack
 Volume: 50uL , 250uL
 Material: Medical grade polypropylene
 Temperature range: -80°C-121°C

Agilent Pipette Tips	A-GEN Model	Volume(μL)	Sterile	Low-Retention	Filtering	Packing
	VT-384-30-RS	30	✓			384 pcs/rack, 10 racks /box, 5 boxes/carton
	VT-384-30-RSL	30	✓	✓		384 pcs/rack, 10 racks /box, 5 boxes/carton
	VT-384-70-RS	70	✓			384 pcs/rack, 10 racks /box, 5 boxes/carton
	VT-384-70-RSL	70	✓	✓		384 pcs/rack, 10 racks /box, 5 boxes/carton
	VT-250-R	250				96 pcs/rack, 10 racks /box, 5 boxes/carton
	VT-250-RL	250		✓		96 pcs/rack, 10 racks /box, 5 boxes/carton
	VT-250-RS	250	✓			96 pcs/rack, 10 racks /box, 5 boxes/carton
	VT-250-RSL	250	✓	✓		96 pcs/rack, 10 racks /box, 5 boxes/carton
	VTF-250-RS	250	✓		✓	96 pcs/rack, 10 racks /box, 5 boxes/carton
	VTF-250-RSL	250	✓	✓	✓	96 pcs/rack, 10 racks /box, 5 boxes/carton

Compatible with Agilent Bravo and Vprep / AMTK , LH-1510/LH-1510+ automatic liquid handling workstation.

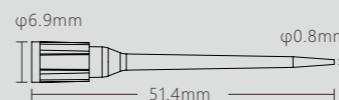
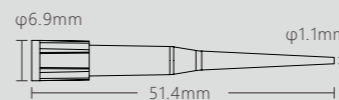
Beckman Pipette Tips	A-GEN Model	Volume(μL)	Sterile	Low-Retention	Filtering	Packing
	BK-50-R	50				96 pcs/rack, 10 racks /box, 5 boxes/carton
	BK-50-RL	50		✓		96 pcs/rack, 10 racks /box, 5 boxes/carton
	BK-50-RS	50	✓			96 pcs/rack, 10 racks /box, 5 boxes/carton
	BK-50-RSL	50	✓	✓		96 pcs/rack, 10 racks /box, 5 boxes/carton
	BKF-50-RS	50	✓		✓	96 pcs/rack, 10 racks /box, 5 boxes/carton
	BKF-50-RSL	50	✓	✓	✓	96 pcs/rack, 10 racks /box, 5 boxes/carton
	BK-250-R	250				96 pcs/rack, 10 racks /box, 5 boxes/carton
	BK-250-RL	250		✓		96 pcs/rack, 10 racks /box, 5 boxes/carton
	BK-250-RS	250	✓			96 pcs/rack, 10 racks /box, 5 boxes/carton
	BK-250-RSL	250	✓	✓		96 pcs/rack, 10 racks /box, 5 boxes/carton
	BKF-250-RS	250	✓		✓	96 pcs/rack, 10 racks /box, 5 boxes/carton
	BKF-250-RSL	250	✓	✓	✓	96 pcs/rack, 10 racks /box, 5 boxes/carton



Compatible with Biomek i5 , Biomek i7 NAYO , NAYO 96 automatic liquid handling workstation.

Compatible List For Tecan Transparent Tips



Package: 96 pcs/rack
 Volume: 20uL , 50uL , 200uL , 1000uL
 Material: Medical grade polypropylene
 Temperature range: -80°C-121°C

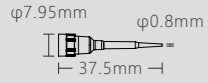

Tecan Tips (Transparent)	A-GEN Model	Volume(μL)	Sterile	Low-Retention	Filtering	Packing
	TT-20-R	20				96 pcs/rack, 24 racks/carton
	TT-20-RL	20		✓		96 pcs/rack, 24 racks/carton
	TT-20-RS	20	✓			96 pcs/rack, 24 racks/carton
	TT-20-RSL	20	✓	✓		96 pcs/rack, 24 racks/carton
	TTF-20-RS	20	✓		✓	96 pcs/rack, 24 racks/carton
	TTF-20-RSL	20	✓	✓	✓	96 pcs/rack, 24 racks/carton
	TT-50-R	50				96 pcs/rack, 24 racks/carton
	TT-50-RL	50		✓		96 pcs/rack, 24 racks/carton
	TT-50-RS	50	✓			96 pcs/rack, 24 racks/carton
	TT-50-RSL	50	✓	✓		96 pcs/rack, 24 racks/carton
	TTF-50-RS	50	✓		✓	96 pcs/rack, 24 racks/carton
	TTF-50-RSL	50	✓	✓	✓	96 pcs/rack, 24 racks/carton

Compatible with Tecan LiHa / ALLSHENG, Au-mate 96 automated pipetting workstation.

Tecan Tips (Transparent)	A-GEN Model	Volume(μL)	Sterile	Low-Retention	Filtering	Packing
	TT-200-R	200				96 pcs/rack, 24 racks/carton
	TT-200-RL	200		✓		96 pcs/rack, 24 racks/carton
	TT-200-RS	200	✓			96 pcs/rack, 24 racks/carton
	TT-200-RSL	200	✓	✓		96 pcs/rack, 24 racks/carton
	TTF-200-RS	200	✓		✓	96 pcs/rack, 24 racks/carton
	TTF-200-RSL	200	✓	✓	✓	96 pcs/rack, 24 racks/carton

Compatible with Tecan LiHa / ALLSHENG, Au-mate 96 automated pipetting workstation.

- Tecan Tips (20uL)**
Type: sterilized, low retention, Filtering
- Tecan Tips (50uL)**
Type: sterilized, low retention, Filtering
- Tecan Tips (200uL)**
Type: sterilized, low retention, Filtering
- Tecan Tips (1000uL)**
Type: sterilized, low retention, Filtering



Tecan Tips (Transparent)	A-GEN Model	Volume(μL)	Sterile	Low-Retention	Filtering	Packing
	TT-1000-R	1000				96 pcs/rack, 16 racks/carton
	TT-1000-RL	1000		✓		96 pcs/rack, 16 racks/carton
	TT-1000-RS	1000	✓			96 pcs/rack, 16 racks/carton
	TT-1000-RSL	1000	✓	✓		96 pcs/rack, 16 racks/carton
	TTF-1000-RS	1000	✓		✓	96 pcs/rack, 16 racks/carton
	TTF-1000-RSL	1000	✓	✓	✓	96 pcs/rack, 16 racks/carton

Compatible with Tecan LiHa / ALLSHENG, Au-mate 96 automated pipetting workstation.



Compatible List For Tecan Transparent Tips

Transparent, SBS Rack Box



Package: 96 pcs/rack
 Volume: 20uL , 50uL , 200uL , 1000uL
 Material: Medical grade polypropylene
 Temperature range: -80°C-121°C

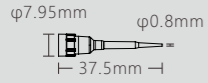

Tecan Tips (Transparent)	A-GEN Model	Volume(μL)	Sterile	Low-Retention	Filtering	Packing
	TT-20-H	20				96 pcs/rack, 24 racks/carton
	TT-20-HL	20		✓		96 pcs/rack, 24 racks/carton
	TT-20-HS	20	✓			96 pcs/rack, 24 racks/carton
	TT-20-HSL	20	✓	✓		96 pcs/rack, 24 racks/carton
	TTF-20-HS	20	✓		✓	96 pcs/rack, 24 racks/carton
	TTF-20-HSL	20	✓	✓	✓	96 pcs/rack, 24 racks/carton
	TT-50-H	50				96 pcs/rack, 24 racks/carton
	TT-50-HL	50		✓		96 pcs/rack, 24 racks/carton
	TT-50-HS	50	✓			96 pcs/rack, 24 racks/carton
	TT-50-HSL	50	✓	✓		96 pcs/rack, 24 racks/carton
	TTF-50-HS	50	✓		✓	96 pcs/rack, 24 racks/carton
	TTF-50-HSL	50	✓	✓	✓	96 pcs/rack, 24 racks/carton

Compatible with Tecan LiHa / ALLSHENG, Auto-Pure 4800 automated pipetting workstation.

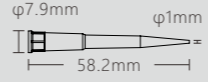
Tecan Tips (Transparent)	A-GEN Model	Volume(μL)	Sterile	Low-Retention	Filtering	Packing
	TT-200-H	200				96 pcs/rack, 24 racks/carton
	TT-200-HL	200		✓		96 pcs/rack, 24 racks/carton
	TT-200-HS	200	✓			96 pcs/rack, 24 racks/carton
	TT-200-HSL	200	✓	✓		96 pcs/rack, 24 racks/carton
	TTF-200-HS	200	✓		✓	96 pcs/rack, 24 racks/carton
	TTF-200-HSL	200	✓	✓	✓	96 pcs/rack, 24 racks/carton

Compatible with Tecan LiHa / ALLSHENG, Auto-Pure 4800 automated pipetting workstation.

- Tecan Tips (20uL)**
Type: sterilized, low retention, Filtering
- Tecan Tips (50uL)**
Type: sterilized, low retention, Filtering
- Tecan Tips (200uL)**
Type: sterilized, low retention, Filtering
- Tecan Tips (1000uL)**
Type: sterilized, low retention, Filtering

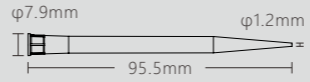

Tecan Tips (Transparent)	A-GEN Model	Volume(μL)	Sterile	Low-Retention	Filtering	Packing
	TT-1000-H	1000				96 pcs/rack, 16 racks/carton
	TT-1000-HL	1000		✓		96 pcs/rack, 16 racks/carton
	TT-1000-HS	1000	✓			96 pcs/rack, 16 racks/carton
	TT-1000-HSL	1000	✓	✓		96 pcs/rack, 16 racks/carton
	TTF-1000-HS	1000	✓		✓	96 pcs/rack, 16 racks/carton
	TTF-1000-HSL	1000	✓	✓	✓	96 pcs/rack, 16 racks/carton



Compatible with Tecan LiHa / ALLSHENG, Auto-Pure 4800 automated pipetting workstation.

Compatible List For Tecan Conductive Tips



Package: 96 pcs/rack
 Volume: 20uL , 50uL , 200uL , 1000uL
 Material: Medical grade polypropylene
 Temperature range: -80°C-121°C

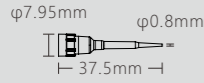

Tecan Tips (conductive)	A-GEN Model	Volume(μL)	Sterile	Low-Retention	Filtering	Packing
	TT-20C-R	20				96 pcs/rack, 24 racks/carton
	TT-20C-RL	20		✓		96 pcs/rack, 24 racks/carton
	TT-20C-RS	20	✓			96 pcs/rack, 24 racks/carton
	TT-20C-RSL	20	✓	✓		96 pcs/rack, 24 racks/carton
	TTF-20C-RS	20	✓		✓	96 pcs/rack, 24 racks/carton
	TTF-20C-RSL	20	✓	✓	✓	96 pcs/rack, 24 racks/carton
	TT-50C-R	50				96 pcs/rack, 24 racks/carton
	TT-50C-RL	50		✓		96 pcs/rack, 24 racks/carton
	TT-50C-RS	50	✓			96 pcs/rack, 24 racks/carton
	TT-50C-RSL	50	✓	✓		96 pcs/rack, 24 racks/carton
	TTF-50C-RS	50	✓		✓	96 pcs/rack, 24 racks/carton
	TTF-50C-RSL	50	✓	✓	✓	96 pcs/rack, 24 racks/carton

Compatible with Tecan LiHa, For Genesis Freedom, Freedom Evo / ALLSHENG, Auto-Pure 4800 automated pipetting workstation.

Tecan Tips (conductive)	A-GEN Model	Volume(μL)	Sterile	Low-Retention	Filtering	Packing
	TT-200C-R	200				96 pcs/rack, 24 racks/carton
	TT-200C-RL	200		✓		96 pcs/rack, 24 racks/carton
	TT-200C-RS	200	✓			96 pcs/rack, 24 racks/carton
	TT-200C-RSL	200	✓	✓		96 pcs/rack, 24 racks/carton
	TTF-200C-RS	200	✓		✓	96 pcs/rack, 24 racks/carton
	TTF-200C-RSL	200	✓	✓	✓	96 pcs/rack, 24 racks/carton

Compatible with Tecan LiHa, For Genesis Freedom, Freedom Evo / ALLSHENG, Auto-Pure 4800 automated pipetting workstation.

- 1 **Tecan Tips (20uL)**
Type: sterilized, low retention, Filtering
- 2 **Tecan Tips (50uL)**
Type: sterilized, low retention, Filtering
- 3 **Tecan Tips (200uL)**
Type: sterilized, low retention, Filtering
- 4 **Tecan Tips (1000uL)**
Type: sterilized, low retention, Filtering

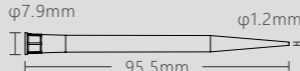

Tecan Tips (conductive)	A-GEN Model	Volume(μL)	Sterile	Low-Retention	Filtering	Packing
	TT-1000C-R	1000				96 pcs/rack, 16 racks/carton
	TT-1000C-RL	1000		✓		96 pcs/rack, 16 racks/carton
	TT-1000C-RS	1000	✓			96 pcs/rack, 16 racks/carton
	TT-1000C-RSL	1000	✓	✓		96 pcs/rack, 16 racks/carton
	TTF-1000C-RS	1000	✓		✓	96 pcs/rack, 16 racks/carton
	TTF-1000C-RSL	1000	✓	✓	✓	96 pcs/rack, 16 racks/carton

Compatible with Tecan LiHa, For Genesis Freedom, Freedom Evo / ALLSHENG, Auto-Pure 4800 automated pipetting workstation.



Compatible List For Tecan Conductive Tips

Conductive, SBS Rack Box



Package: 96 pcs/rack
 Volume: 20uL, 50uL, 200uL, 1000uL, 5000uL
 Material: Medical grade polypropylene
 Temperature range: -80°C-121°C

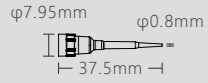

Tecan Tips (conductive)	A-GEN Model	Volume(μL)	Sterile	Low-Retention	Filtering	Packing
	TT-20C-H	20				96 pcs/rack, 24 racks/carton
	TT-20C-HL	20		✓		96 pcs/rack, 24 racks/carton
	TT-20C-HS	20	✓			96 pcs/rack, 24 racks/carton
	TT-20C-HSL	20	✓	✓		96 pcs/rack, 24 racks/carton
	TTF-20C-HS	20	✓		✓	96 pcs/rack, 24 racks/carton
	TTF-20C-HSL	20	✓	✓	✓	96 pcs/rack, 24 racks/carton
	TT-50C-H	50				96 pcs/rack, 24 racks/carton
	TT-50C-HL	50		✓		96 pcs/rack, 24 racks/carton
	TT-50C-HS	50	✓			96 pcs/rack, 24 racks/carton
	TT-50C-HSL	50	✓	✓		96 pcs/rack, 24 racks/carton
	TTF-50C-HS	50	✓		✓	96 pcs/rack, 24 racks/carton
	TTF-50C-HSL	50	✓	✓	✓	96 pcs/rack, 24 racks/carton

Compatible with Tecan LiHa, For Genesis Freedom, Freedom Evo / ALLSHENG, Auto-Pure 4800 automated pipetting workstation.

Tecan Tips (conductive)	A-GEN Model	Volume(μL)	Sterile	Low-Retention	Filtering	Packing
	TT-200C-H	200				96 pcs/rack, 24 racks/carton
	TT-200C-HL	200		✓		96 pcs/rack, 24 racks/carton
	TT-200C-HS	200	✓			96 pcs/rack, 24 racks/carton
	TT-200C-HSL	200	✓	✓		96 pcs/rack, 24 racks/carton
	TTF-200C-HS	200	✓		✓	96 pcs/rack, 24 racks/carton
	TTF-200C-HSL	200	✓	✓	✓	96 pcs/rack, 24 racks/carton
	TT-1000C-H	1000				96 pcs/rack, 16 racks/carton
	TT-1000C-HL	1000		✓		96 pcs/rack, 16 racks/carton
	TT-1000C-HS	1000	✓			96 pcs/rack, 16 racks/carton
	TT-1000C-HSL	1000	✓	✓		96 pcs/rack, 16 racks/carton
	TTF-1000C-HS	1000	✓		✓	96 pcs/rack, 16 racks/carton
	TTF-1000C-HSL	1000	✓	✓	✓	96 pcs/rack, 16 racks/carton

- 1 Tecan Tips (20uL)**
Type: sterilized, low retention, Filtering
- 2 Tecan Tips (50uL)**
Type: sterilized, low retention, Filtering
- 3 Tecan Tips (200uL)**
Type: sterilized, low retention, Filtering
- 4 Tecan Tips (1000uL)**
Type: sterilized, low retention, Filtering
- 5 Tecan Tips (5000uL)**
Type: sterilized, low retention, Filtering

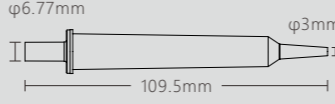

Tecan Tips (conductive)	A-GEN Model	Volume(μL)	Sterile	Low-Retention	Filtering	Packing
	TT-5000C-H	5000				96 pcs/rack, 16 racks/carton
	TT-5000C-HL	5000		✓		96 pcs/rack, 16 racks/carton
	TT-5000C-HS	5000	✓			96 pcs/rack, 16 racks/carton
	TT-5000C-HSL	5000	✓	✓		96 pcs/rack, 16 racks/carton
	TTF-5000C-HS	5000	✓		✓	96 pcs/rack, 16 racks/carton
	TTF-5000C-HSL	5000	✓	✓	✓	96 pcs/rack, 16 racks/carton

Compatible with Tecan LiHa, For Genesis Freedom, Freedom Evo / ALLSHENG, Auto-Pure 4800 automated pipetting workstation.

Compatibility List For Hamilton Conductive Tips



Package: 96 pcs/rack
 Volume: 50uL , 300uL , 1000uL
 Material: Medical grade polypropylene
 Temperature range: -80°C-121°C

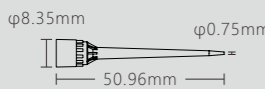
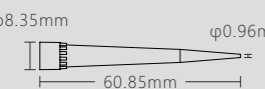
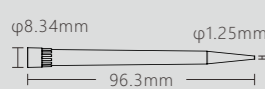

Hamilton Tips (conductive)	A-GEN Model	Volume(μL)	Sterile	Low-Retention	Filtering	Packing
	HT-50C-RS	50	✓			96 pcs/rack, 36 racks/carton
	HT-50C-RSL	50	✓	✓		96 pcs/rack, 36 racks/carton
	HTF-50C-RS	50	✓		✓	96 pcs/rack, 36 racks/carton
	HTF-50C-RSL	50	✓	✓	✓	96 pcs/rack, 36 racks/carton
	HT-300C-RS	300	✓			96 pcs/rack, 36 racks/carton
	HT-300C-RSL	300	✓	✓		96 pcs/rack, 36 racks/carton
	HTF-300C-RS	300	✓		✓	96 pcs/rack, 36 racks/carton
	HTF-300C-RSL	300	✓	✓	✓	96 pcs/rack, 36 racks/carton
	HT-1000C-RS	1000	✓			96 pcs/rack, 24 racks/carton
	HT-1000C-RSL	1000	✓	✓		96 pcs/rack, 24 racks/carton
	HTF-1000C-RS	1000	✓		✓	96 pcs/rack, 24 racks/carton
	HTF-1000C-RSL	1000	✓	✓	✓	96 pcs/rack, 24 racks/carton

Compatible with the liquid handling workstation of Hamilton Star, Starlet and N imbus.

Compatibility List For Opentrons Tips



Package: 96 pcs/rack
 Volume: 20uL , 200uL , 1000uL
 Material: Medical grade polypropylene
 Temperature range: -80°C-121°C

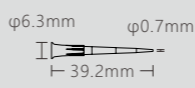
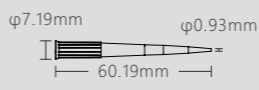
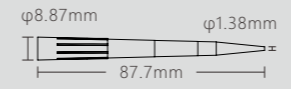

Opentrons Pipette Tips	A-GEN Model	Volume(μL)	Sterile	Low-Retention	Filtering	Packing
	OPT-20-RS	20	✓			96 pcs/rack, 10 racks /box, 5 boxes/carton
	OPT-20-RSL	20	✓	✓		96 pcs/rack, 10 racks /box, 5 boxes/carton
	OPTF-20-RS	20	✓		✓	96 pcs/rack, 10 racks /box, 5 boxes/carton
	OPTF-20-RSL	20	✓	✓	✓	96 pcs/rack, 10 racks /box, 5 boxes/carton
	OPT-20-ES	20	✓			96 pcs /layer, 10 layers/box (reloading package)
	OPT-20-ESL	20	✓	✓		96 pcs /layer, 10 layers/box (reloading package)
	OPT-200-RS	200	✓			96 pcs/rack, 10 racks /box, 5 boxes/carton
	OPT-200-RSL	200	✓	✓		96 pcs/rack, 10 racks /box, 5 boxes/carton
	OPTF-200-RS	200	✓		✓	96 pcs/rack, 10 racks /box, 5 boxes/carton
	OPTF-200-RSL	200	✓	✓	✓	96 pcs/rack, 10 racks /box, 5 boxes/carton
	OPT-200-ES	200	✓			96 pcs /layer, 10 layers/box (reloading package)
	OPT-200-ESL	200	✓	✓		96 pcs /layer, 10 layers/box (reloading package)
	OPT-1000-RS	1000	✓			96 pcs/rack, 10 racks /box, 5 boxes/carton
	OPT-1000-RSL	1000	✓	✓		96 pcs/rack, 10 racks /box, 5 boxes/carton
	OPTF-1000-RS	1000	✓		✓	96 pcs/rack, 10 racks /box, 5 boxes/carton
	OPTF-1000-RSL	1000	✓	✓	✓	96 pcs/rack, 10 racks /box, 5 boxes/carton
	OPT-1000-ES	1000	✓			96 pcs /layer, 10 layers/box (reloading package)
	OPT-1000-ESL	1000	✓	✓		96 pcs /layer, 10 layers/box (reloading package)

Compatible with the liquid handling workstation of Opentrons, OT-2 Robot.

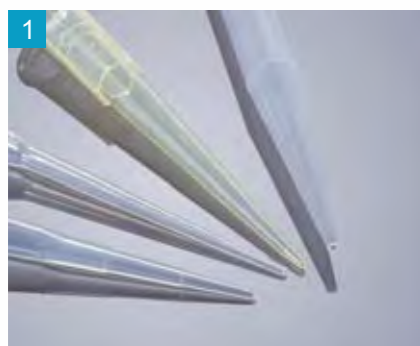
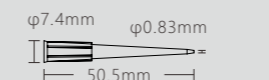
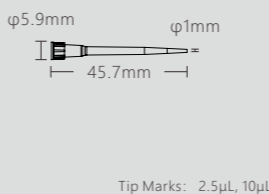
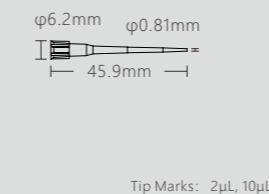
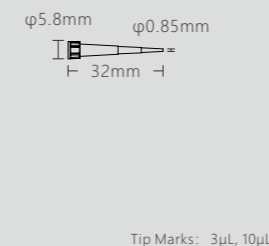

Universal Pipette Tips (Non-Filtered)



10µL Tips	A-GEN Model	Volume(µL)	Sterile	Low-Retention	Filtering	Packing
	T-10-B	0.5-10				1000 pcs/pack, 20 packs/carton
	T-10-BL	0.5-10		✓		1000 pcs/pack, 20 packs/carton
	T-10-R	0.5-10				96 pcs/rack, 10 racks /box, 5 boxes/carton
	T-10-RL	0.5-10			✓	96 pcs/rack, 10 racks /box, 5 boxes/carton
	T-10-RS	0.5-10	✓			96 pcs/rack, 10 racks /box, 5 boxes/carton
	T-10-RSL	0.5-10	✓	✓		96 pcs/rack, 10 racks /box, 5 boxes/carton
	T-10-E	0.5-10				96 pcs/rack, 10 racks /box, 10 boxes/carton
	T-10-EL	0.5-10			✓	96 pcs/rack, 10 racks /box, 10 boxes/carton
10µL Extra Long Tips	A-GEN Model	Volume(µL)	Sterile	Low-Retention	Filtering	Packing
	T-11-B	0.5-10				1000 pcs/pack, 20 packs/carton
	T-11-BL	0.5-10		✓		1000 pcs/pack, 20 packs/carton
	T-11-R	0.5-10				96 pcs/rack, 10 racks /box, 5 boxes/carton
	T-11-RL	0.5-10			✓	96 pcs/rack, 10 racks /box, 5 boxes/carton
	T-11-RS	0.5-10	✓			96 pcs/rack, 10 racks /box, 5 boxes/carton
	T-11-RSL	0.5-10	✓	✓		96 pcs/rack, 10 racks /box, 5 boxes/carton
10µL Extra Long Tips	A-GEN Model	Volume(µL)	Sterile	Low-Retention	Filtering	Packing
	T-12-B	0.5-10				1000 pcs/pack, 20 packs/carton
	T-12-BL	0.5-10		✓		1000 pcs/pack, 20 packs/carton
	T-12-R	0.5-10				96 pcs/rack, 10 racks /box, 5 boxes/carton
	T-12-RL	0.5-10			✓	96 pcs/rack, 10 racks /box, 5 boxes/carton
	T-12-RS	0.5-10	✓			96 pcs/rack, 10 racks /box, 5 boxes/carton
	T-12-RSL	0.5-10	✓	✓		96 pcs/rack, 10 racks /box, 5 boxes/carton
200µL Tips (Yellow)	A-GEN Model	Volume(µL)	Sterile	Low-Retention	Filtering	Packing
	T-200Y-B	10-200				1000 pcs/pack, 20 packs/carton
	T-200Y-BL	10-200		✓		1000 pcs/pack, 20 packs/carton
	T-200Y-R	10-200				96 pcs/rack, 10 racks /box, 5 boxes/carton
	T-200Y-RL	10-200			✓	96 pcs/rack, 10 racks /box, 5 boxes/carton
	T-200Y-RS	10-200	✓			96 pcs/rack, 10 racks /box, 5 boxes/carton
	T-200Y-RSL	10-200	✓	✓		96 pcs/rack, 10 racks /box, 5 boxes/carton
	T-200Y-E	10-200				96 pcs/rack, 10 racks /box, 10 boxes/carton
	T-200Y-EL	10-200			✓	96 pcs/rack, 10 racks /box, 10 boxes/carton

Compatible with a variety of pipettors, suitable for pipetting micro reagent from deep vessels.

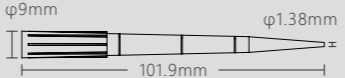
300µL Tips	A-GEN Model	Volume(µL)	Sterile	Low-Retention	Filtering	Packing
 <p>Tip Marks: 10µL, 50µL, 100µL</p>	T-300-B	10-300				1000 pcs/pack, 20 packs/carton
	T-300-BL	10-300		✓		1000 pcs/pack, 20 packs/carton
	T-300-R	10-300				96 pcs/rack, 10 racks /box, 5 boxes/carton
	T-300-RL	10-300		✓		96 pcs/rack, 10 racks /box, 5 boxes/carton
	T-300-RS	10-300	✓			96 pcs/rack, 10 racks /box, 5 boxes/carton
	T-300-RSL	10-300	✓	✓		96 pcs/rack, 10 racks /box, 5 boxes/carton
	T-300-E	10-300				96 pcs/rack, 10 racks/box, 10 boxes/carton
	T-300-EL	10-300		✓		96 pcs/rack, 10 racks/box, 10 boxes/carton
300µL Extra Long Tips	A-GEN Model	Volume(µL)	Sterile	Low-Retention	Filtering	Packing
 <p>Tip Marks: 20µL, 50µL, 100µL, 200µL</p>	T-301-B	10-300				1000 pcs/pack, 5 packs/carton
	T-301-BL	10-300		✓		1000 pcs/pack, 5 packs/carton
	T-301-R	10-300				96 pcs/rack, 10 racks /box, 5 boxes/carton
	T-301-RL	10-300		✓		96 pcs/rack, 10 racks /box, 5 boxes/carton
	T-301-RS	10-300	✓			96 pcs/rack, 10 racks /box, 5 boxes/carton
	T-301-RSL	10-300	✓	✓		96 pcs/rack, 10 racks /box, 5 boxes/carton
	T-301-E	10-300				96 pcs/rack, 5 racks/box, 10 boxes/carton
	T-301-EL	10-300		✓		96 pcs/rack, 5 racks/box, 10 boxes/carton
300µL Extra Long Tips	A-GEN Model	Volume(µL)	Sterile	Low-Retention	Filtering	Packing
 <p>Tip Marks: 30µL, 100µL, 200µL, 300µL</p>	T-302-B	10-300				1000 pcs/pack, 5 packs/carton
	T-302-BL	10-300		✓		1000 pcs/pack, 5 packs/carton
	T-302-R	10-300				96 pcs/rack, 10 racks /box, 5 boxes/carton
	T-302-RL	10-300		✓		96 pcs/rack, 10 racks /box, 5 boxes/carton
	T-302-RS	10-300	✓			96 pcs/rack, 10 racks /box, 5 boxes/carton
	T-302-RSL	10-300	✓	✓		96 pcs/rack, 10 racks /box, 5 boxes/carton
1000µL Tips (Blue)	A-GEN Model	Volume(µL)	Sterile	Low-Retention	Filtering	Packing
 <p>Tip Marks: 200µL, 500µL</p>	T-1000B-B	100-1000				1000 pcs/pack, 5 packs/carton
	T-1000B-BL	100-1000		✓		1000 pcs/pack, 5 packs/carton
	T-1000B-R	100-1000				96 pcs/rack, 10 racks /box, 5 boxes/carton
	T-1000B-RL	100-1000		✓		96 pcs/rack, 10 racks /box, 5 boxes/carton
	T-1000B-RS	100-1000	✓			96 pcs/rack, 10 racks /box, 5 boxes/carton
	T-1000B-RSL	100-1000	✓	✓		96 pcs/rack, 10 racks /box, 5 boxes/carton
	T-1000B-E	100-1000				96 pcs/rack, 5 racks/box, 10 boxes/carton
	T-1000B-EL	100-1000		✓		96 pcs/rack, 5 racks/box, 10 boxes/carton

1250µL Tips	A-GEN Model	Volume(µL)	Sterile	Low-Retention	Filtering	Packing
 <p>Tip Marks: 200µL, 500µL, 1000µL</p>	T-1250-B	100-1250				1000 pcs/pack, 5 packs/carton
	T-1250-BL	100-1250		✓		1000 pcs/pack, 5 packs/carton
	T-1250-R	100-1250				96 pcs/rack, 10 racks /box, 5 boxes/carton
	T-1250-RL	100-1250		✓		96 pcs/rack, 10 racks /box, 5 boxes/carton
	T-1250-RS	100-1250	✓			96 pcs/rack, 10 racks /box, 5 boxes/carton
	T-1250-RSL	100-1250	✓	✓		96 pcs/rack, 10 racks /box, 5 boxes/carton
	T-1250-E	100-1250				96 pcs/rack, 5 racks/box, 10 boxes/carton
	T-1250-EL	100-1250		✓		96 pcs/rack, 5 racks/box, 10 boxes/carton
1500µL Tips	A-GEN Model	Volume(µL)	Sterile	Low-Retention	Filtering	Packing
 <p>Tip Marks: 500µL, 1000µL, 1500µL</p>	T-1500-B	100-1500				1000 pcs/pack, 5 packs/carton
	T-1500-BL	100-1500		✓		1000 pcs/pack, 5 packs/carton
	T-1500-R	100-1500				96 pcs/rack, 5 racks/box, 5 boxes/carton
	T-1500-RL	100-1500		✓		96 pcs/rack, 5 racks/box, 5 boxes/carton
	T-1500-RS	100-1500	✓			96 pcs/rack, 5 racks/box, 5 boxes/carton
	T-1500-RSL	100-1500	✓	✓		96 pcs/rack, 5 racks/box, 5 boxes/carton

Compatible with a variety of pipettors, suitable for pipetting micro reagent from deep vessels.

Integra Pipette Tips

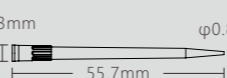
Integra Tips	A-GEN Model	Volume(µL)	Sterile	Low-Retention	Filtering	Packing
	IG-384-12.5-RS	12.5	✓			384 pcs/rack, 10 racks/box, 5 boxes/carton
	IG-384-125-RS	125	✓			384 pcs/rack, 10 racks/box, 5 boxes/carton

Compatible with Integra pipettors, suitable for pipette micro liquid from deep vessels.

Universal Pipette Tips (Filter Element)



10µL Tips	A-GEN Model	Volume(µL)	Sterile	Low-Retention	Filtering	Packing
	TF-10-B	0.5-10			✓	1000 pcs/pack, 10 packs/carton
	TF-10-BL	0.5-10		✓	✓	1000 pcs/pack, 10 packs/carton
	TF-10-RS	0.5-10	✓		✓	96 pcs/rack, 10 racks /box, 5 boxes/carton
	TF-10-RSL	0.5-10	✓	✓	✓	96 pcs/rack, 10 racks /box, 5 boxes/carton
10µL Extra Long Tips	A-GEN Model	Volume(µL)	Sterile	Low-Retention	Filtering	Packing
	TF-11-B	0.5-10			✓	1000 pcs/pack, 10 packs/carton
	TF-11-BL	0.5-10		✓	✓	1000 pcs/pack, 10 packs/carton
	TF-11-RS	0.5-10	✓		✓	96 pcs/rack, 10 racks /box, 5 boxes/carton
	TF-11-RSL	0.5-10	✓	✓	✓	96 pcs/rack, 10 racks /box, 5 boxes/carton
10µL Extra Long Tips	A-GEN Model	Volume(µL)	Sterile	Low-Retention	Filtering	Packing
	TF-12-B	0.5-10			✓	1000 pcs/pack, 10 packs/carton
	TF-12-BL	0.5-10		✓	✓	1000 pcs/pack, 10 packs/carton
	TF-12-RS	0.5-10	✓		✓	96 pcs/rack, 10 racks /box, 5 boxes/carton
	TF-12-RSL	0.5-10	✓	✓	✓	96 pcs/rack, 10 racks /box, 5 boxes/carton
20µL Tips (Yellow)	A-GEN Model	Volume(µL)	Sterile	Low-Retention	Filtering	Packing
	TF-20Y-B	1.0-20			✓	1000 pcs/pack, 10 packs/carton
	TF-20Y-BL	1.0-20		✓	✓	1000 pcs/pack, 10 packs/carton
	TF-20Y-RS	1.0-20	✓		✓	96 pcs/rack, 10 racks /box, 5 boxes/carton
	TF-20Y-RSL	1.0-20	✓	✓	✓	96 pcs/rack, 10 racks /box, 5 boxes/carton
50µL Tips (Yellow)	A-GEN Model	Volume(µL)	Sterile	Low-Retention	Filtering	Packing
	TF-50Y-B	5-50			✓	1000 pcs/pack, 10 packs/carton
	TF-50Y-BL	5-50		✓	✓	1000 pcs/pack, 10 packs/carton
	TF-50Y-RS	5-50	✓		✓	96 pcs/rack, 10 racks /box, 5 boxes/carton
	TF-50Y-RSL	5-50	✓	✓	✓	96 pcs/rack, 10 racks /box, 5 boxes/carton
100µL Tips	A-GEN Model	Volume(µL)	Sterile	Low-Retention	Filtering	Packing
	TF-100-B	10-100			✓	1000 pcs/pack, 10 packs/carton
	TF-100-BL	10-100		✓	✓	1000 pcs/pack, 10 packs/carton
	TF-100-RS	10-100	✓		✓	96 pcs/rack, 10 racks /box, 5 boxes/carton
	TF-100-RSL	10-100	✓	✓	✓	96 pcs/rack, 10 racks /box, 5 boxes/carton

Compatible with a variety of pipettors, suitable for pipetting micro reagent from deep vessels.

200µL Tips	A-GEN Model	Volume(µL)	Sterile	Low-Retention	Filtering	Packing	
 <p>Tip Marks: 10µL, 50µL, 100µL</p>	TF-200-B	10-200			✓	1000 pcs/pack, 10 packs/carton	
	TF-200-BL	10-200		✓	✓	1000 pcs/pack, 10 packs/carton	
	TF-200-RS	10-200	✓		✓	96 pcs/rack, 10 racks /box, 5 boxes/carton	
	TF-200-RSL	10-200	✓	✓	✓	96 pcs/rack, 10 racks /box, 5 boxes/carton	
300µL Tips	A-GEN Model	Volume(µL)	Sterile	Low-Retention	Filtering	Packing	
 <p>Tip Marks: 10µL, 50µL, 100µL</p>	TF-300-B	10-300			✓	1000 pcs/pack, 10 packs/carton	
	TF-300-BL	10-300		✓	✓	1000 pcs/pack, 10 packs/carton	
	TF-300-RS	10-300	✓		✓	96 pcs/rack, 10 racks /box, 5 boxes/carton	
	TF-300-RSL	10-300	✓	✓	✓	96 pcs/rack, 10 racks /box, 5 boxes/carton	
300µL Extra Long Tips	A-GEN Model	Volume(µL)	Sterile	Low-Retention	Filtering	Packing	
 <p>Tip Marks: 20µL, 50µL, 100µL, 200µL</p>	TF-301-B	10-300			✓	1000 pcs/pack, 5 packs/carton	
	TF-301-BL	10-300		✓	✓	1000 pcs/pack, 5 packs/carton	
	TF-301-RS	10-300	✓		✓	96 pcs/rack, 10 racks /box, 5 boxes/carton	
	TF-301-RSL	10-300	✓	✓	✓	96 pcs/rack, 10 racks /box, 5 boxes/carton	
300µL Extra Long Tips	A-GEN Model	Volume(µL)	Sterile	Low-Retention	Filtering	Packing	
 <p>Tip Marks: 30µL, 100µL, 200µL, 300µL</p>	T-302-B	10-300				1000 pcs/pack, 5 packs/carton	
	T-302-BL	10-300		✓			1000 pcs/pack, 5 packs/carton
	T-302-R	10-300					96 pcs/rack, 10 racks /box, 5 boxes/carton
	T-302-RL	10-300			✓		96 pcs/rack, 10 racks /box, 5 boxes/carton
	T-302-RS	10-300	✓				96 pcs/rack, 10 racks /box, 5 boxes/carton
	T-302-RSL	10-300	✓	✓			96 pcs/rack, 10 racks /box, 5 boxes/carton
1000µL (Blue)	A-GEN Model	Volume(µL)	Sterile	Low-Retention	Filtering	Packing	
 <p>Tip Marks: 200µL, 500µL</p>	TF-1000B-B	100-1000			✓	1000 pcs/pack, 5 packs/carton	
	TF-1000B-BL	100-1000		✓	✓	1000 pcs/pack, 5 packs/carton	
	TF-1000B-RS	100-1000	✓		✓	96 pcs/rack, 10 racks /box, 5 boxes/carton	
	TF-1000B-RSL	100-1000	✓	✓	✓	96 pcs/rack, 10 racks /box, 5 boxes/carton	
1250µL Tips	A-GEN Model	Volume(µL)	Sterile	Low-Retention	Filtering	Packing	
 <p>Tip Marks: 200µL, 500µL, 1000µL</p>	TF-1250-B	100-1250			✓	1000 pcs/pack, 5 packs/carton	
	TF-1250-BL	100-1250		✓	✓	1000 pcs/pack, 5 packs/carton	
	TF-1250-RS	100-1250	✓		✓	96 pcs/rack, 10 racks /box, 5 boxes/carton	
	TF-1250-RSL	100-1250	✓	✓	✓	96 pcs/rack, 10 racks /box, 5 boxes/carton	

Compatible with a variety of pipettors, suitable for pipetting micro reagent from deep vessels.

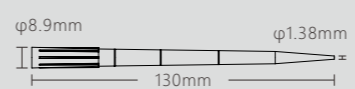
1500µL Tips	A-GEN Model	Volume(µL)	Sterile	Low-Retention	Filtering	Packing
 <p>Tip Marks: 500µL, 1000µL, 1500µL</p>	TF-1500-B	100-1500				1000 pcs/pack, 5 packs/carton
	TF-1500-BL	100-1500		✓		1000 pcs/pack, 5 packs/carton
	TF-1500-R	100-1500				96 pcs/rack, 10 racks /box, 5 boxes/carton
	TF-1500-RL	100-1500			✓	96 pcs/rack, 10 racks /box, 5 boxes/carton
	TF-1500-RS	100-1500	✓			96 pcs/rack, 10 racks /box, 5 boxes/carton
	TF-1500-RSL	100-1500	✓	✓		96 pcs/rack, 10 racks /box, 5 boxes/carton

Compatible with a variety of pipettors, suitable for pipetting micro reagent from deep vessels.

Gel Sampling Pipette Tips

Gel Sampling Pipette Tips	A-GEN Model	Volume(µL)	Sterile	Low-Retention	Filtering	Packing
	TGL-200-R	200				96 pcs/rack, 10 racks /box, 5 boxes/carton
	TGLF-160-RS	160	✓		✓	96 pcs/rack, 10 racks /box, 5 boxes/carton

Compatible with a variety of pipettors, suitable for pipetting micro reagent from deep vessels.

For Rainin Pipettor



20µL Tips



200µL Tips



300µL Tips



1000µL Tips

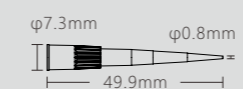
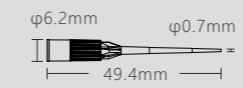

20µL Tips	A-GEN Model	Volume(µL)	Sterile	Low-Retention	Filtering	Packing
	LTS-20-B	0.5-20				1000 pcs/pack, 10 packs/carton
	LTS-20-BL	0.5-20		✓		1000 pcs/pack, 10 packs/carton
	LTS-20-R	0.5-20				96 pcs/rack, 10 racks /box, 5 boxes/carton
	LTS-20-RL	0.5-20		✓		96 pcs/rack, 10 racks /box, 5 boxes/carton
	LTS-20-RS	0.5-20	✓			96 pcs/rack, 10 racks /box, 5 boxes/carton
	LTS-20-RSL	0.5-20	✓	✓		96 pcs/rack, 10 racks /box, 5 boxes/carton
	LTS-20-E	0.5-20				96 pcs/rack, 10 racks /box, 10 boxes/carton
	LTS-20-EL	0.5-20		✓		96 pcs/rack, 10 racks /box, 10 boxes/carton
	LTSF-20-B	0.5-20			✓	1000 pcs/pack, 10 packs/carton
	LTSF-20-BL	0.5-20		✓	✓	1000 pcs/pack, 10 packs/carton
	LTSF-20-RS	0.5-20	✓		✓	96 pcs/rack, 10 racks /box, 5 boxes/carton
	LTSF-20-RSL	0.5-20	✓	✓	✓	96 pcs/rack, 10 racks /box, 5 boxes/carton
Tip Marks: 2µL, 10µL, 20µL						
200µL Tips	A-GEN Model	Volume(µL)	Sterile	Low-Retention	Filtering	Packing
	LTS-200-B	10-200				1000 pcs/pack, 10 packs/carton
	LTS-200-BL	10-200		✓		1000 pcs/pack, 10 packs/carton
	LTS-200-R	10-200				96 pcs/rack, 10 racks /box, 5 boxes/carton
	LTS-200-RL	10-200		✓		96 pcs/rack, 10 racks /box, 5 boxes/carton
	LTS-200-RS	10-200	✓			96 pcs/rack, 10 racks /box, 5 boxes/carton
	LTS-200-RSL	10-200	✓	✓		96 pcs/rack, 10 racks /box, 5 boxes/carton
	LTS-200-E	10-200				96 pcs /layer, 10 layers/box, 10 boxes/carton
	LTS-200-EL	10-200		✓		96 pcs /layer, 10 layers/box, 10 boxes/carton
	LTSF-200-B	10-200			✓	1000 pcs/pack, 10 packs/carton
	LTSF-200-BL	10-200		✓	✓	1000 pcs/pack, 10 packs/carton
	LTSF-200-RS	10-200	✓		✓	96 pcs/rack, 10 racks /box, 5 boxes/carton
	LTSF-200-RSL	10-200	✓	✓	✓	96 pcs/rack, 10 racks /box, 5 boxes/carton
Tip Marks: 10µL, 50µL, 100µL, 200µL						

Compatible with Rainin, For LiteTouch System, XLS pipette.

30µL Tips	A-GEN Model	Volume(µL)	Sterile	Low-Retention	Filtering	Packing
	LTS-300-B	10-300				1000 pcs/pack, 10 packs/carton
	LTS-300-BL	10-300		✓		1000 pcs/pack, 10 packs/carton
	LTS-300-R	10-300				96 pcs/rack, 10 racks /box, 5 boxes/carton
	LTS-300-RL	10-300		✓		96 pcs/rack, 10 racks /box, 5 boxes/carton
	LTS-300-RS	10-300	✓			96 pcs/rack, 10 racks /box, 5 boxes/carton
	LTS-300-RSL	10-300	✓	✓		96 pcs/rack, 10 racks /box, 5 boxes/carton
	LTS-300-E	10-300				96 pcs /layer, 8 layers/box, 10 boxes/carton
	LTS-300-EL	10-300			✓	96 pcs /layer, 8 layers/box, 10 boxes/carton
	LTSF-300-B	10-300			✓	1000 pcs/pack, 10 packs/carton
	LTSF-300-BL	10-300			✓	1000 pcs/pack, 10 packs/carton
	LTSF-300-RS	10-300	✓		✓	96 pcs/rack, 10 racks /box, 5 boxes/carton
LTSF-300-RSL	10-300	✓	✓	✓	96 pcs/rack, 10 racks /box, 5 boxes/carton	
1000µL Tips	A-GEN Model	Volume(µL)	Sterile	Low-Retention	Filtering	Packing
	LTS-1000-B	100-1000				1000 pcs/pack, 10 packs/carton
	LTS-1000-BL	100-1000		✓		1000 pcs/pack, 10 packs/carton
	LTS-1000-R	100-1000				96 pcs/rack, 10 racks /box, 5 boxes/carton
	LTS-1000-RL	100-1000		✓		96 pcs/rack, 10 racks /box, 5 boxes/carton
	LTS-1000-RS	100-1000	✓			96 pcs/rack, 10 racks /box, 5 boxes/carton
	LTS-1000-RSL	100-1000	✓	✓		96 pcs/rack, 10 racks /box, 5 boxes/carton
	LTS-1000-E	100-1000				96 pcs /layer, 8 layers/box, 10 boxes/carton
	LTS-1000-EL	100-1000			✓	96 pcs /layer, 8 layers/box, 10 boxes/carton
	LTSF-1000-B	100-1000			✓	1000 pcs/pack, 5 packs/carton
	LTSF-1000-BL	100-1000			✓	1000 pcs/pack, 5 packs/carton
	LTSF-1000-RS	100-1000	✓		✓	96 pcs/rack, 10 racks /box, 5 boxes/carton
LTSF-1000-RSL	100-1000	✓	✓	✓	96 pcs/rack, 10 racks /box, 5 boxes/carton	

Compatible with Rainin, For LiteTouch System, XLS pipette.

Pipette Tip Package



Rack Package

- ✓ **One-Handed Performance**
To improve the working efficiency.
- ✓ **Translucent Lid**
Different color for different volume, easy to recognize.
- ✓ **Individual Rack Package**
individual package to prevent pollution.

Reloading Package

- ✓ **To Save Space**
There are 8 or 10 layers tips in every package , and it can be reloaded.
- ✓ **Easy To Operate**
It can reload the individual rack in some seconds by the reloading package.
- ✓ **Environmental Friendly**
The package way can save 60% plastic usage.

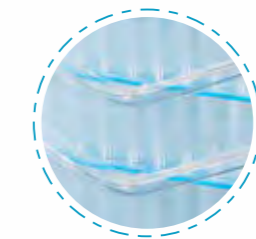

Individually Rack

Easy to use

96 pcs/rack



Stacked Box Packaging

Save space and reduce plastic waste by 60%

96 pcs/layer



Bagged Packing

Save space and reduce plastic waste by 85%



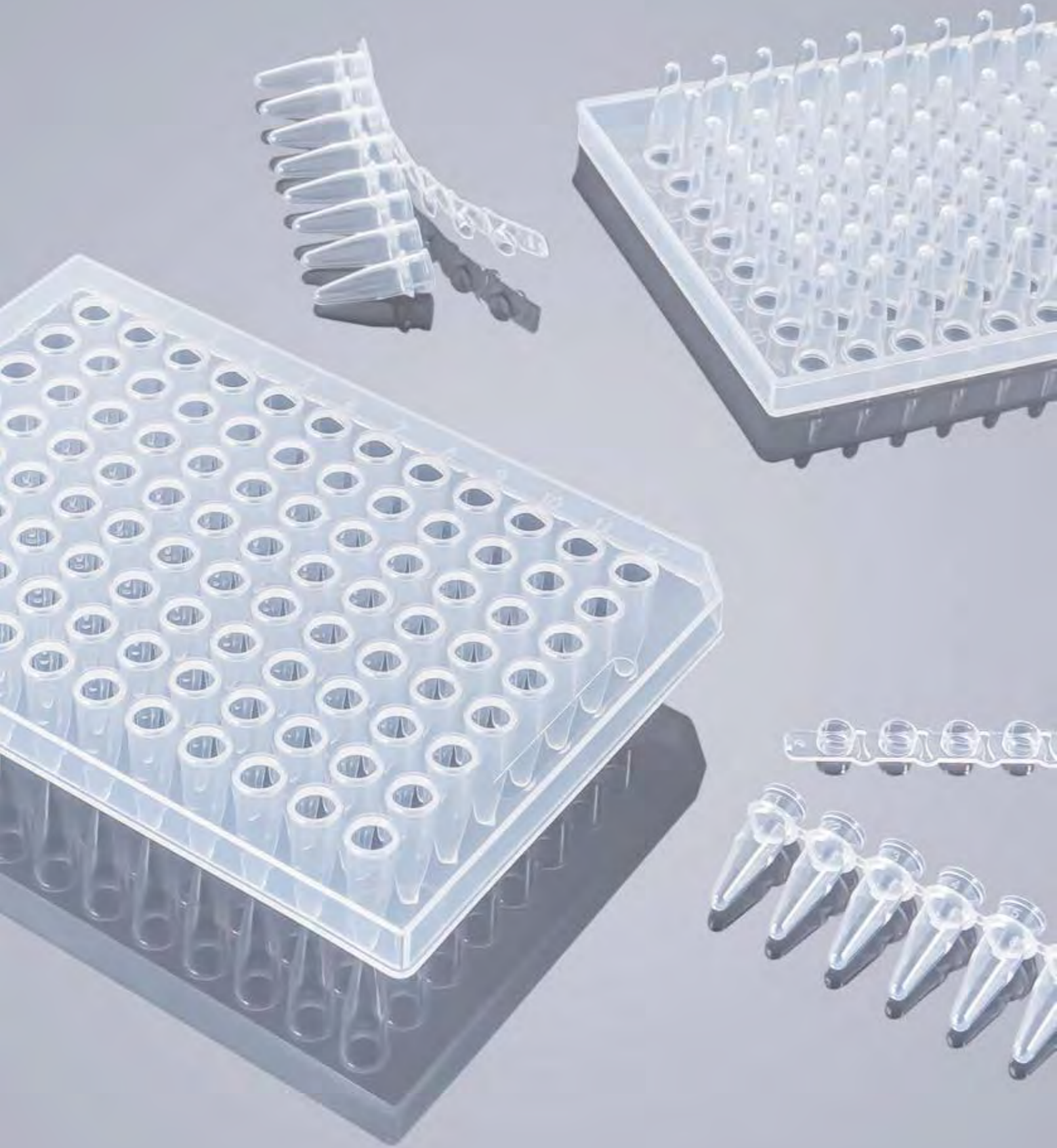

1000 pcs/bag

Variety of sizes, types and packaging are available to meet needed.

■ 20 µL ■ 200 µL ■ 300 µL ■ 1000 µL

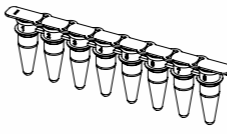
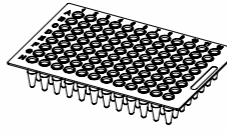
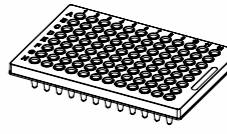
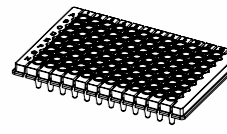

PCR Plate

			
PCR-0208	PCR-96-HN-C	PCR-96-HS-C	PCR-96R-HS-C
PCR Tube Strips	96 PCR Plate (No Profile)	96 PCR Plate (Half Profile)	96 PCR Plate (Half Profile, Removable)
8 Holes (0.2 mL)	96 Holes (0.2 mL)	96 Holes (0.2 mL)	96 Holes (0.2 mL)
			
71X8X20.6 mm	119.8X79.7X21 mm	126.3X86X21.1 mm	127.76X85.48X20.7 mm
125 pcs/bag, 10 bags/carton	10 pcs/bag, 5 bags/carton	10 pcs/bag, 5 bags/carton	10 pcs/bag, 5 bags/carton

A full range of PCR plates, printing services can be provided.

PCR Cover (Sealing film/Silicone Mat) :

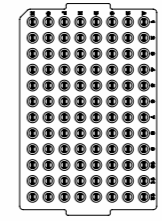
	
F-101	M-PCR-RD-96
Adaptation, full series of PCR plates	Adaptation, full series of PCR plates
Features: PCR fluorescence quantification	Features: Round hole, pierceable
130X80 mm	113.5X77.5 mm
125 pcs/bag, 10 bags/carton	10 pcs/bag, 5 bags/carton



Round Well Plate

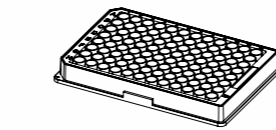

P-0.36-96V

V Bottom

96 Holes

0.36 mL



127.8X85.5X14.8 mm

10 pcs/bag, 100 pcs/carton

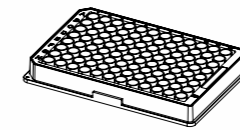

P-0.4-96F

Flat Bottom

96 Holes

0.4 mL



127.8X85.5X14.8 mm

10 pcs/bag, 100 pcs/carton

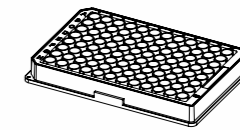

P-0.4-96U

U Bottom

96 Holes

0.4 mL



127.8X85.5X14.8 mm

10 pcs/bag, 100 pcs/carton

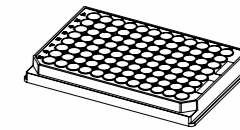

P-0.45-RDV-96

V Bottom

96 Holes

0.45 mL



127.15X85.2X14.5 mm

10 pcs/bag, 100 pcs/carton

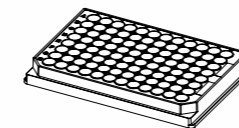

P-0.5-RD-96

U Bottom

96 Holes

0.5 mL

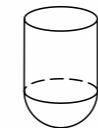

127.15X85.2X14.5 mm

10 pcs/bag, 100 pcs/carton

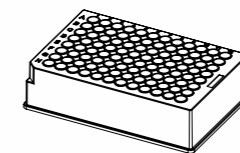

P-1.0-RD-96

U Bottom, Independent Well

96 Holes

1.0 mL



127.8X85.5X33 mm

5 pcs/bag, 50 pcs/carton

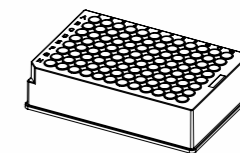

P-1.0-RDV-96

V Bottom

96 Holes

1.0 mL



127.8X85.5X33 mm

5 pcs/bag, 50 pcs/carton

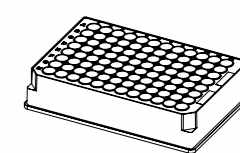

P-1.1-RD-96

U Bottom, Shared Well

96 Holes

1.1 mL

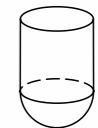

127.5X85.35X27 mm

5 pcs/bag, 50 pcs/carton

Round Well Plate

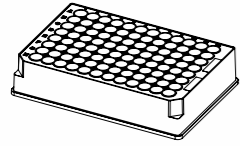

P-1.1-RDV-96

V Bottom, Shared Well

96 Holes

1.1 mL



127.5X85.35X27 mm

5 pcs/bag, 50 pcs/carton

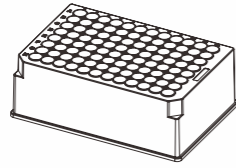

P-2.0-RDA-96

U Bottom

96 Holes

2.0 mL

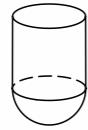

127.5X85.35X44.3 mm

5 pcs/bag, 50 pcs/carton

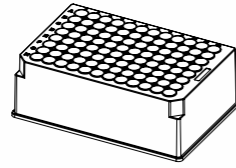

P-2.0-RDV-96

V Bottom

96 Holes

2.0 mL



127.5X85.35X44.3 mm

5 pcs/bag, 50 pcs/carton

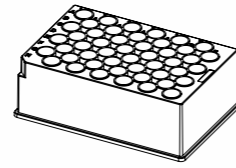

P-3.5-RD-48

U Bottom, Irregular Arrangement

48 Holes

3.5 mL



127.8X85.5X43.6 mm

5 pcs/bag, 50 pcs/carton

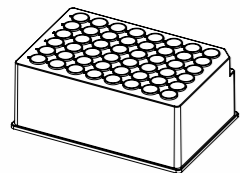

P-3.5-RDA-48

U Bottom, Regular Arrangement

48 Holes

3.5 mL

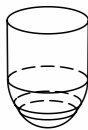

127.5X85.2X51.1 mm

5 pcs/bag, 50 pcs/carton

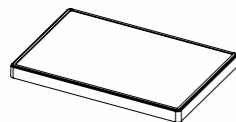

P-C

Transparent Plate Cover

/

Adaptation, full series of PCR plates

/

129.2X86X9.3 mm

20 pcs/bag, 200 pcs/carton

Square Well Plate

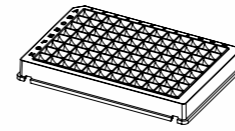

P-0.5-SQV-96

Tapered Bottom

96 Holes

0.5 mL



127.5X85.4X15.1 mm

10 pcs/bag, 100 pcs/carton

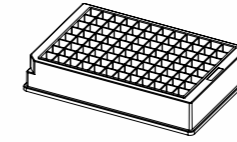

P-1.0-SQ-96

U Bottom

96 Holes

1.0 mL



127.8X85.5X24.4 mm

10 pcs/bag, 100 pcs/carton

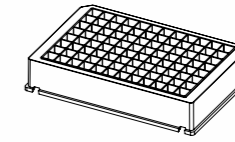

P-1.0-SQV-96

Tapered Bottom

96 Holes

1.0 mL



127.4X85.5X24.4 mm

10 pcs/bag, 100 pcs/carton

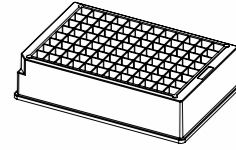

P-1.6-SQ-96

U Bottom

96 Holes

1.6 mL



127.5X85.4X31.6 mm

5 pcs/bag, 50 pcs/carton

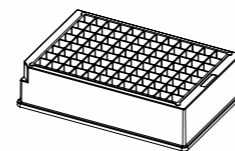

P-1.6-SQV-96

V Bottom

96 Holes

1.6 mL

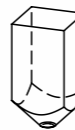

127.5X85.4X31.6 mm

5 pcs/bag, 50 pcs/carton

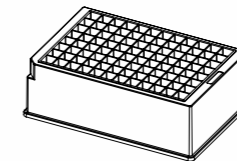

P-2.2-SQ-96

U Bottom

96 Holes

2.2 mL



127.5X85.4X41.6 mm

5 pcs/bag, 50 pcs/carton

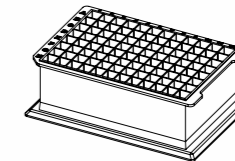

P-2.2-SQG-96

U Bottom, Profile Concave

96 Holes

2.2 mL



127X85X42.5 mm

5 pcs/bag, 50 pcs/carton

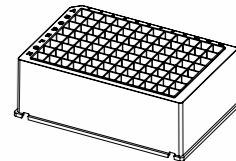

P-2.2-SQV-96

Tapered Bottom, Frosted Shell

96 Holes

2.2 mL

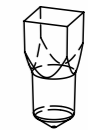

127.4X85.5X44.2 mm

5 pcs/bag, 50 pcs/carton

Square Well Plate

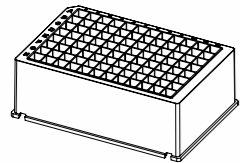

P-2.2-SQVT-96

Tapered Bottom, Transparent Shell

96 Holes

2.2 mL



127.4X85.5X44.2 mm

5 pcs/bag, 50 pcs/carton

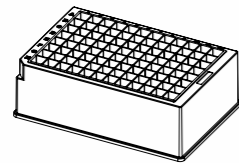

P-2.3-SQV-96

V Bottom

96 Holes

2.3 mL

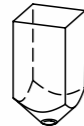

127.5X85.4X41.7 mm

5 pcs/bag, 50 pcs/carton

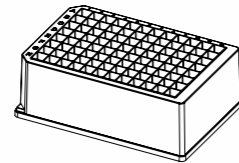

P-2.3-SQC-96

Diamond Cone Bottom

96 Holes

2.3 mL



127.3X85.2X44.3 mm

5 pcs/bag, 50 pcs/carton

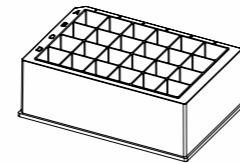

P-10-SQV-24

Tapered Bottom

24 Holes

10 mL



127.5X85.5X44 mm

5 pcs/bag, 50 pcs/carton

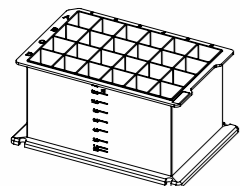

P-15-SQV-24

Tapered Bottom

24 Holes

15 mL



127.2X85.3X63.2 mm

5 pcs/bag, 50 pcs/carton

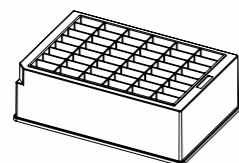

P-4.6-SQ-48

U Bottom

48 Holes

4.6 mL

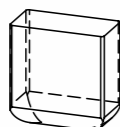

127.8X85.5X41.6 mm

5 pcs/bag, 50 pcs/carton

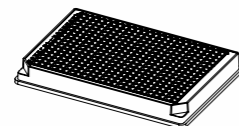

P-120-SQ-384

V Bottom

384 Holes

120 µL

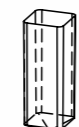

127.5X85.35X14.6 mm

10 pcs/white box, 100 pcs/carton

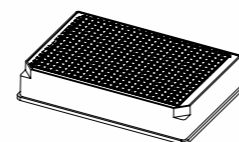

P-240-SQ-384

V Bottom

384 Holes

240 µL



127.5X83.35X24.9 mm

10 pcs/white box, 50 pcs/carton

Silicone Mat For Well Plate



DEEP WELL PLATE

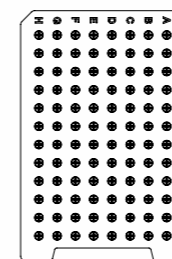

M-RD-96-U

Adaptation
1.0 mL round well plate

Features
Round hole, can be pierced

10 pcs/bag, 5 bags/carton



M-2mL-RD

Adaptation
2.0 mL round well plate

Features
Round hole, can be pierced

10 pcs/bag, 5 bags/carton

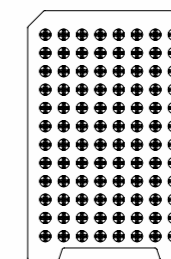

M-2mL-RD-C

Adaptation
2.0 mL round well plate

Features
Cross cut, pierceable

10 pcs/bag, 5 bags/carton

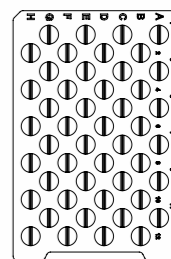





M-RD-3.5mL



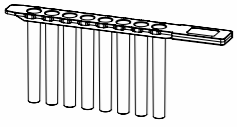
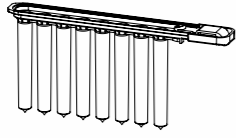
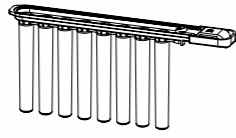
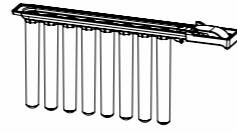

Adaptation
3.5 mL round well plate

Features
Round hole, pierceable

10 pcs/bag, 5 bags/carton

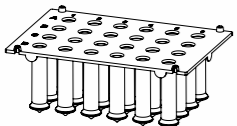
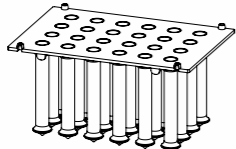
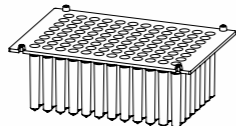
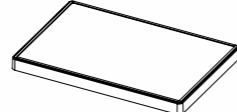
Tip Comb And Pc-Cover



			
P-MT-8U	J-MT-8V	D-MT-8U	SS-MT-8U
U Bottom	V Bottom, Snap	U Bottom, Snap	U Bottom, Snap
8 Holes	8 Holes	8 Holes	8 Holes
Adaptation 2.2 mL square well plate	Adaptation 2.2 mL square well plate	Adaptation 2.2 mL square well plate	Adaptation 2.2 mL square well plate
			
11.45X44.7 mm	12X45.5 mm	12X46.1 mm	11.8X45.8 mm
200 sets/carton	200 sets/carton	200 sets/carton	200 sets/carton

			
P-MT-24	P-MT-24L	P-MT-96V	P-C
V Bottom	V Bottom	V Bottom	Transparent Plate Cover
24 Holes	24 Holes	96 Holes	/
Adaptation 10 mL square well plate	Adaptation 15 mL square well plate	Adaptation 2.2 mL square well plate	Adaptation full range of well plates
			/
126.5X84.9X44.2 mm	127.4X85.3X62.2 mm	127.3X85.3X42.3 mm	129.2X86X9.3 mm
50 sets/carton	50 sets/carton	50 sets/carton	20 pcs/bag, 200 pieces/carton

Compatible With TANBEAD

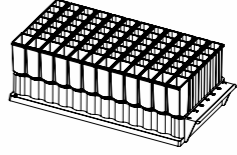
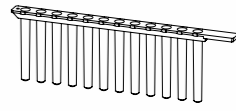
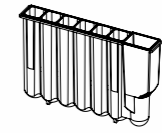

Suit for TANBEAD SLA-D14800 pipetting workstation.

	
P-SQ-84R	P-MT-12U
Square Well Pate, Detachable	Snap, PP
84 Holes	12 Holes
Suit for TANBEAD pipetting workstation	Suit for TANBEAD square well pate
	
152.3X81.8X52.7 mm	12X56.2 mm
16 pcs/bag, 30 bags/carton	15 pcs/bag, 4 bags/carton

DEEP WELL PLATE

Reservoir

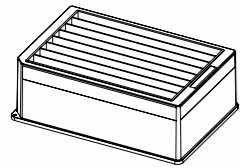

RES-32-8MW

Multi Well, High Profile

8 Channel

32 mL

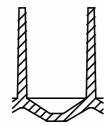

127.76X85.48X44.5 mm

5 pcs/bag, 50 pcs/carton

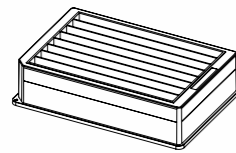

RES-180-8MW

Multi Well, Middle Profile

8 Channel

22 mL

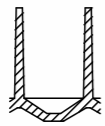

127.76X85.48X31.5 mm

5 pcs/bag, 50 pcs/carton

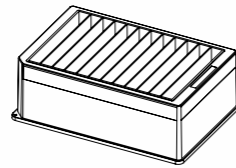

RES-22-12MW

Multi Well, High Profile

12 Channel

22 mL

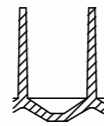

127.76X85.48X44.5 mm

5 pcs/bag, 50 pcs/carton

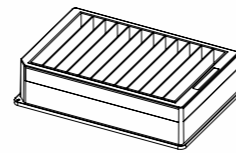

RES-180-12MW

Multi Well, Middle Profile

12 Channel

15 mL

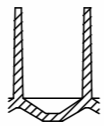

127.76X85.48X31.5 mm

5 pcs/bag, 50 pcs/carton

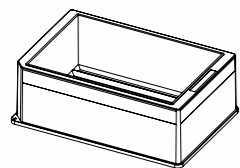

RES-290-8SW

Single Well, High Profile

8 Channel

290 mL



127.76X85.48X44.5 mm

5 pcs/bag, 50 pcs/carton

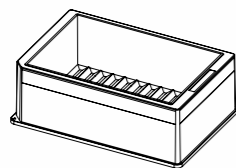

RES-290-12SW

Single Well, High Profile

12 Channel

290 mL



127.76X85.48X44.5 mm

5 pcs/bag, 50 pcs/carton

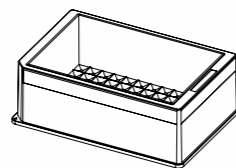

RES-290-96SW

Single Well, High Profile

96 Channel

290 mL



127.76X85.48X44.5 mm

5 pcs/bag, 50 pcs/carton

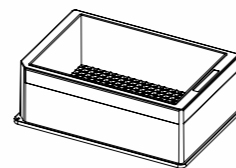

RES-290-384SW

Single Well, High Profile

384 Channel

290 mL



127.76X85.48X44.5 mm

5 pcs/bag, 50 pcs/carton

Reservoir

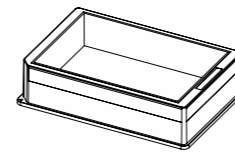

RES-190-F

Single Well, Middle Profile

Flat Channel

190 mL

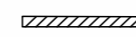

127.76X85.48X31.5 mm

5 pcs/bag, 50 pcs/carton

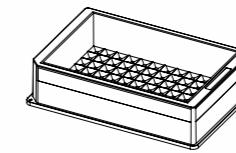

RES-195-96SW

Single Well, Middle Profile

96 Channel

195 mL

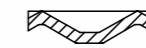

127.76X85.48X31.5 mm

5 pcs/bag, 50 pcs/carton

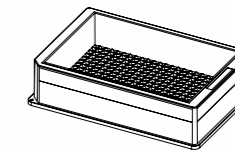

RES-185-384SW

Single Well, Middle Profile

384 Channel

185 mL



127.76X85.48X31.5 mm

5 pcs/bag, 50 pcs/carton

Reservoir Accessories

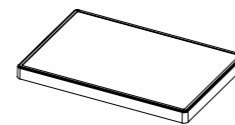

P-C

Transparent Plate Cover

Adaptation full range of reservoirs

129.2X86X9.3 mm

20 pcs/bag, 200 pcs/carton

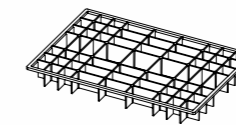

RSB-B-I-S

Wave breaker (sterilized)

Adaptation 96/384 channel reservoir

111.5X75.2X11.5 mm

20 pcs/box, 100 pcs/carton

Reagent Tank



10 mL Reagent Slot	A-GEN Model	Volume(mL)	Type	Packing
	RES-PS10	10	Bulk	100 pc/bag
	RES-PS10-1S	10	Individual Pack, Sterilization	1 pc/bag, 100 bags/case
	RES-PS10-5S	10	5 pc/bag, Sterilization	5 pc/bag, 40 bags/case

25 mL Reagent Slot	A-GEN Model	Volume(mL)	Type	Packing
	RES-PS25	25	Bulk	100 pc/bag
	RES-PS25-1S	25	Individual Pack, Sterilization	1 pc/bag, 100 bags/case
	RES-PS25-5S	25	5 pc/bag, Sterilization	5 pc/bag, 40 bags/case
50 mL Reagent Slot	A-GEN Model	Volume(mL)	Type	Packing
	RES-PS50	50	Bulk	100 pc/bag
	RES-PS50-1S	50	Individual Pack, Sterilization	1 pc/bag, 100 bags/case
	RES-PS50-5S	50	5 pc/bag, Sterilization	5 pc/bag, 40 bags/case
65 mL Reagent Slot	A-GEN Model	Volume(mL)	Type	Packing
	RES-PS65	65	Bulk	100 pc/bag
	RES-PS65-1S	65	Individual Pack, Sterilization	1 pc/bag, 100 bags/case
	RES-PS65-5S	65	5 pc/bag, Sterilization	5 pc/bag, 40 bags/case
100 mL Reagent Slot	A-GEN Model	Volume(mL)	Type	Packing
	RES-PS100	100	Bulk	100 pc/bag
	RES-PS100-1S	100	Individual Pack, Sterilization	1 pc/bag, 100 bags/case
	RES-PS100-5S	100	5 pc/bag, Sterilization	5 pc/bag, 40 bags/case

RESERVIOR



Tube/Column

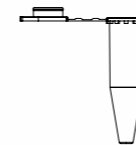

T-001

Centrifuge Tube with long cap

1.5 mL

Centrifugal Force 12000g

50 pcs/bag, 100 bags/carton

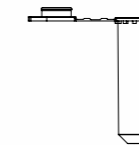

T-002

Centrifuge Tube with long cap

2.0 mL

Centrifugal Force 12000g

50 pcs/bag, 100 bags/carton



T-003

Spin Preparation Column with ring

0.7 mL

Centrifugal Force 12000g

1000 pcs/bag, 10 bags/carton



T-004

Spin Gel Column with ring

0.7 mL

Centrifugal Force 12000g

1000 pcs/bag, 10 bags/carton

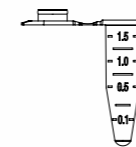

T-005

micro centrifuge tube with cap

1.5 mL

Centrifugal Force 12000g

500 pcs/bag, 10 bags/carton

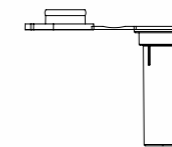

T-007

Purification Spin Column Flat bottom/with cover and ring

0.7 mL

Centrifugal Force 12000g

1000 pcs/bag, 10 bags/carton



T-008

micro centrifuge tube no cap, non-graduated

2.0 mL

Centrifugal Force 12000g

1000 pcs/bag, 15 bags/carton

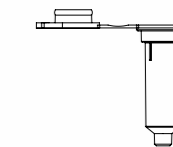

T-009

Purification Spin Column including pressure ring

0.7 mL

Centrifugal Force 12000g

1000 pcs/bag, 10 bags/carton

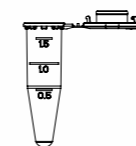

CT-1.5

Centrifuge Tube Double explosion proof buckle

1.5 mL

Centrifugal Force 12000g

500 pcs/bag, 10 bags/carton

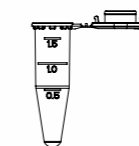

CT-1.5-L

Double explosion proof buckle Low retention

1.5 mL

Centrifugal Force 12000g

500 pcs/bag, 10 bags/carton

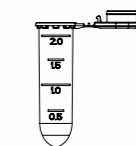

CT-2.0

Centrifuge Tube Double explosion proof buckle

2.0 mL

Centrifugal Force 12000g

500 pcs/bag, 10 bags/carton

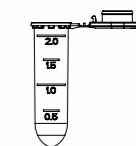

CT-2.0-L

Double explosion proof buckle Low retention

2.0 mL

Centrifugal Force 12000g

500 pcs/bag, 10 bags/carton

Tube/Column



CT-15-S
Centrifuge Tube sterilized
15 mL
Centrifugal Force 12000g
25 pcs/bag, 20 bags/carton



CT-15-RS
Centrifuge Tubes Rack mounted, sterilized
15 mL
Centrifugal Force 12000g
25 pcs/bag, 20 bags/carton



CT-15SS-S
Centrifuge Tubes Can stand, sterilized
15 mL
Centrifugal Force 12000g
25 pcs/bag, 20 bags/carton



CT-15SS-RS
Stand mounted Can stand, sterilized
15 mL
Centrifugal Force 12000g
25 pcs/bag, 20 bags/carton



CT-50-S
Centrifuge Tube sterilized
50 mL
Centrifugal Force 12000g
25 pcs/bag, 20 bags/carton



CT-50-RS
Centrifuge Tubes Rack mounted, sterilized
50 mL
Centrifugal Force 12000g
25/rack, 12/box



CT-50SS-S
Centrifuge Tubes Can stand, sterilized
50 mL
Centrifugal Force 12000g
25 pcs/bag, 20 bags/carton



CT-50SS-RS
Stand mounted Can stand, sterilized
50 mL
Centrifugal Force 12000g
25/rack, 12/box



CT-50SSH-S
Can stand, hexagonal bottom sterilization
50 mL
Centrifugal Force 12000g
25/rack, 12/box



CT-50SSH-RS
Bracket mounted, can stand Hexagonal bottom, sterilized
50 mL
Centrifugal Force 12000g
25/rack, 12/box

Tube/Column Box

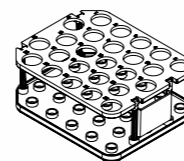

CTR-15
Centrifuge Tube Holder
Adaptation 15 mL centrifuge tube
/
/

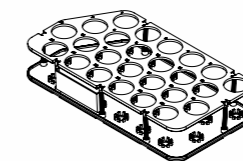

CTR-50
Centrifuge Tube Holder
Adaptation 50 mL centrifuge tube
/
/

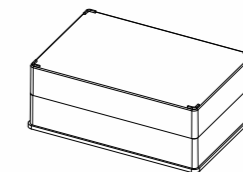

DWP-24PPK-C
Centrifuge Tube Box
Adaptation T-005,CT-1.5,CT-2.0
/
5 pcs/bag, 50 pcs/carton

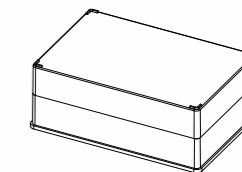

DWP-24PPK-C-S
Centrifuge Tube Box
Adaptation T-005,CT-1.5,CT-2.0
/
5 pcs/bag, 50 pcs/carton

Tube/Column Package



Individually Rack
Easy to use
24/box



Bracket Packaging
Save space and reduce plastic waste by 60%
25/rack



Bagged Packing
Save space and reduce plastic waste by 85%
200 pcs/bag, 500 pcs/bag

Variety of sizes, types and packaging are available to meet needed.

1mL Serological Pipettes (Sterilization)				
纸塑单装 50支/袋, 20袋/箱				
A-GEN Model	Volume	Scale	Color Ring	Packing
SP01001	1 mL	1/100 mL	○	Paper-Plastic Bags, 50 pcs/bag, 20 bags/case
SP02001	1 mL	1/100 mL	○	Plastic Bags, 50 pcs/bag, 20 bags/case
2mL Serological Pipettes (Sterilization)				
A-GEN Model	Volume	Scale	Color Ring	Packing
SP01002	2 mL	1/50 mL	○	Paper-Plastic Bags, 50 pcs/bag, 20 bags/case
SP02002	2 mL	1/50 mL	○	Plastic Bags, 50 pcs/bag, 20 bags/case
5mL Serological Pipettes (Sterilization)				
A-GEN Model	Volume	Scale	Color Ring	Packing
SP01005	5 mL	1/10 mL	○	Paper-Plastic Bags, 50 pcs/bag, 10 bags/case
SP02005	5 mL	1/10 mL	○	Plastic Bags, 50 pcs/bag, 10 bags/case
10mL Serological Pipettes (Sterilization)				
A-GEN Model	Volume	Scale	Color Ring	Packing
SP01010	10 mL	1/10 mL	○	Paper-Plastic Bags, 50 pcs/bag, 10 bags/case
SP02010	10 mL	1/10 mL	○	Plastic Bags, 50 pcs/bag, 10 bags/case

25mL Serological Pipettes (Sterilization)				
A-GEN Model	Volume	Scale	Color Ring	Packing
SP01025	25 mL	2/10 mL	○	Paper-Plastic Bags, 25 pcs/bag, 10 bags/case
SP02025	25 mL	2/10 mL	○	Plastic Bags, 25 pcs/bag, 10 bags/case
50mL Serological Pipettes (Sterilization)				
A-GEN Model	Volume	Scale	Color Ring	Packing
SP01050	50 mL	1/2 mL	○	Paper-Plastic Bags, 25 pcs/bag, 8 bags/case
SP02050	50 mL	1/2 mL	○	Plastic Bags, 25 pcs/bag, 8 bags/case
100mL Serological Pipettes (Sterilization)				
A-GEN Model	Volume	Scale	Color Ring	Packing
SP01100	100 mL	1 mL	○	Paper-Plastic Bags, 20 pcs/bag, 6 bags/case
SP02100	100 mL	1 mL	○	Plastic Bags, 20 pcs/bag, 6 bags/case

Compatible with a variety of pipettors, suitable for pipetting micro reagent from deep vessels.

Compatible with all kinds of pipettes, suitable for measuring a certain volume of liquid and vacuum suction.